

Choose the language

**English**

**Italiano**

**Français**

**Deutsch**

# BCN

## Stool on slide frame

**Metal finish:**

Polished chrome steel  
Steel lacquered in same colour as seat

**Body finish:**





White PBT (colour reference "white polypropylene PP01")  
Black PBT (colour reference "black polypropylene PP03")  
Green PBT (colour reference "fluo green polypropylene PP06")  
Red coral PBT (colour reference "red coral polypropylene PP07")

→ Compared to other colours, black enhances the natural "shading", which is to be considered normal.  
→ Reinforced packaging, see page 205.

Code	Height (cm.)	Legs	Price in EURO	Packs	Vol. m³	Kg
05BCN03	50	colour to match the seat		1	0,13	8
		polished chrome steel				
05BCN02	66	colour to match the seat		1	0,19	10
		polished chrome steel				
05BCN01	76	colour to match the seat		1	0,21	10,2
		polished chrome steel				

1 stool in each package

Stools will be shipped knocked down for orders with more than 6 units.

	Packs	m³	Kg
 nr. 3	1	0,13	12,1
 nr. 6	1	0,22	23,5
H.50  nr. 3	1	0,13	11
H.66/76  nr. 3	1	0,22	15

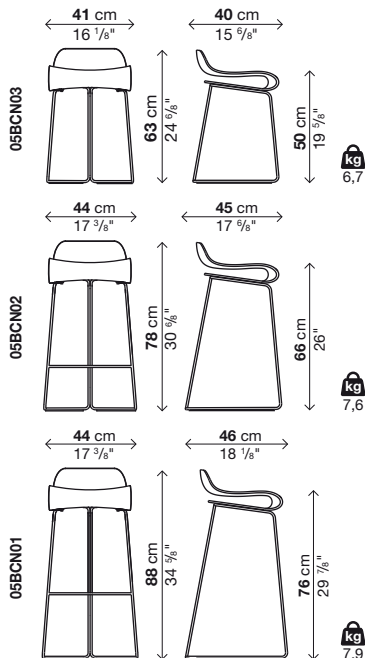

# BCN

## Stool on wooden base

**Base finish:**

Solid beech  
Solid beech lacquered in same colour as seat

**Body finish:**



White PBT (colour reference "white polypropylene PP01")  
Black PBT (colour reference "black polypropylene PP03")  
Green PBT (colour reference "fluo green polypropylene PP06")  
Red coral PBT (colour reference "red coral polypropylene PP07")

→ Compared to other colours, black enhances the natural "shading", which is to be considered normal.  
→ Reinforced packaging, see page 205.

Code	Base	Price in EURO	Packs	Vol. m³	Kg
05BCN08	beech wood		1	0,26	10,5
	colour to match the seat				

1 stool in each package

Stools will be shipped knocked down for orders with more than 6 units.

	Packs	m³	Kg
 nr. 3	1	0,13	12,1
 nr. 6	1	0,22	23,5
A nr. 3	1	0,42	13

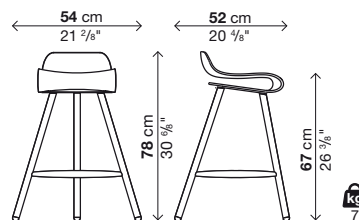

# BCN

## Stool with height adjustment

### Metal finish:

Polished chrome steel

Steel lacquered in same colour as seat

### Body finish:

White PBT (colour reference "white polypropylene PP01")

Black PBT (colour reference "black polypropylene PP03")

Green PBT (colour reference "fluo green polypropylene PP06")

Red coral PBT (colour reference "red coral polypropylene PP07")

→ Compared to other colours, black enhances the natural "shading", which is to be considered normal.

→ Reinforced packaging, see page 205.

Code	Metal finish	Price in EURO	Packs	Vol. <sup>3</sup>	Kg
05BCN04	colour to match the seat		1	0,2	13
	polished chrome steel				

1 stool in each package

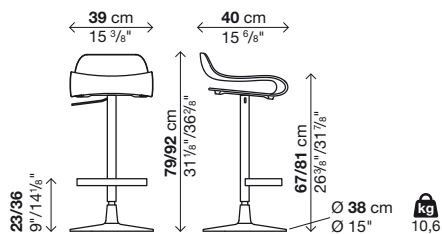

# BCN

## Sgabello su slitta

### Finitura metallo:

Acciaio cromato

Acciaio verniciato in tinta con la seduta

### Finitura seduta:

PBT bianco (riferimento colore "Polipropilene bianco PP01")

PBT nero (riferimento colore "Polipropilene nero PP03")

PBT verde fluo (riferimento colore "Polipropilene verde fluo PP06")

PBT rosso corallo (riferimento colore "Polipropilene rosso corallo PP07")





→ Il colore nero evidenzia maggiormente, rispetto agli altri colori, "ombreggiature" intrinseche del materiale, che sono da ritenersi nella norma.

→ Imballi rinforzati vedi pag. 205.

Codice	Altezza (cm.)	Gambe	Prezzi EURO	colli	m <sup>3</sup>	Kg
05BCN03	50	in tinta con la seduta		1	0,13	8
		acciaio cromato				
05BCN02	66	in tinta con la seduta		1	0,19	10
		acciaio cromato				
05BCN01	76	in tinta con la seduta		1	0,21	10,2
		acciaio cromato				

ogni collo contiene 1 sgabello

Per ordini superiori alle 6 unità, il prodotto viene spedito smontato.

	colli	m <sup>3</sup>	Kg
 nr. 3	1	0,13	12,1
 nr. 6	1	0,22	23,5
H.50  nr. 3	1	0,13	11
H.66/76  nr. 3	1	0,22	15

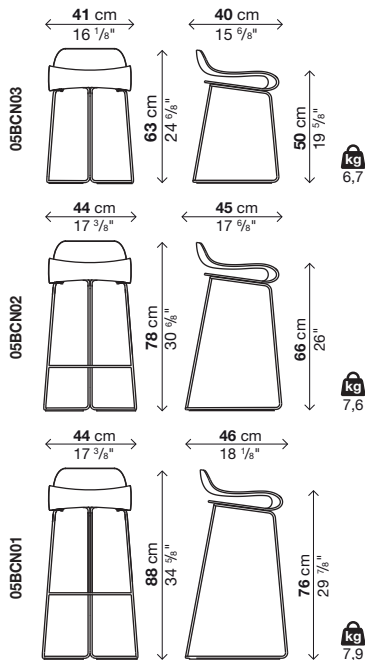

# BCN

## Sgabello su base legno

### Finitura base:

Legno massello di faggio

Legno massello di faggio laccato in tinta con la seduta

### Finitura seduta:

PBT bianco (riferimento colore "Polipropilene bianco PP01")

PBT nero (riferimento colore "Polipropilene nero PP03")

PBT verde fluo (riferimento colore "Polipropilene verde fluo PP06")

PBT rosso corallo (riferimento colore "Polipropilene rosso corallo PP07")



→ Il colore nero evidenzia maggiormente, rispetto agli altri colori, "ombreggiature" intrinseche del materiale, che sono da ritenersi nella norma.

→ Imballi rinforzati vedi pag. 205.

Codice	Base	Prezzi EURO	colli	m <sup>3</sup>	Kg
05BCN08	legno di faggio		1	0,26	10,5
	in tinta con la seduta				

ogni collo contiene 1 sgabello

Per ordini superiori alle 6 unità, il prodotto viene spedito smontato.

	colli	m <sup>3</sup>	Kg
 nr. 3	1	0,13	12,1
 nr. 6	1	0,22	23,5
A nr. 3	1	0,42	13

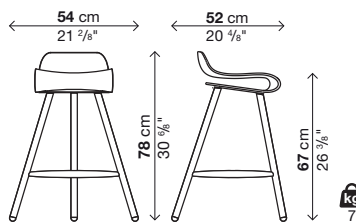

# BCN

## Sgabello regolabile in altezza

### Finitura metallo:

Acciaio cromato

Acciaio verniciato in tinta con la seduta

### Finitura seduta:

PBT bianco (riferimento colore "Polipropilene bianco PP01")

PBT nero (riferimento colore "Polipropilene nero PP03")

PBT verde fluo (riferimento colore "Polipropilene verde fluo PP06")

PBT rosso corallo (riferimento colore "Polipropilene rosso corallo PP07")

→ Il colore nero evidenzia maggiormente, rispetto agli altri colori, "ombreggiature" intrinseche del materiale, che sono da ritenersi nella norma.

→ Imballi rinforzati vedi pag. 205.

Codice	Finitura metallo	Prezzi EURO	colli	m <sup>3</sup>	Kg
05BCN04	in tinta con la seduta acciaio cromato		1	0,2	13

ogni collo contiene 1 sgabello

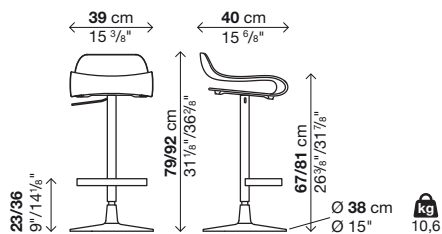

# BCN

## Tabouret piètement luge

### Finition du métal:

Acier chromé

Acier laqué en teinte coordonnée à l'assise

### Finition coque:

Blanc PBT (reference couleur "Polypropylène blanc PP01")

Noir PBT (reference couleur "Polypropylène noir PP03")

Vert fluo PBT (reference couleur "Polypropylène vert fluo PP06")

Corail rouge PBT (reference couleur "Polypropylène corail rouge PP07")





→ La couleur noire, plus que d'autres couleurs, met en évidence certaines caractéristiques telles que les "ombres".

→ Emballages renforcés voir page 205.

Code	Hauteur (cm.)	Pieds	Prix en EURO	Colis	m <sup>3</sup>	Kg
05BCN03	50	en teinte à l'assise		1	0,13	8
		acier chromé				
05BCN02	66	en teinte à l'assise		1	0,19	10
		acier chromé				
05BCN01	76	en teinte à l'assise		1	0,21	10,2
		acier chromé				

chaque colis 1 tabouret

Les commandes de plus de 6 pièces seront livrées démontées.

	Colis	m <sup>3</sup>	Kg
 n° 3	1	0,13	12,1
 n° 6	1	0,22	23,5
H.50  n° 3	1	0,13	11
H.66/76  n° 3	1	0,22	15

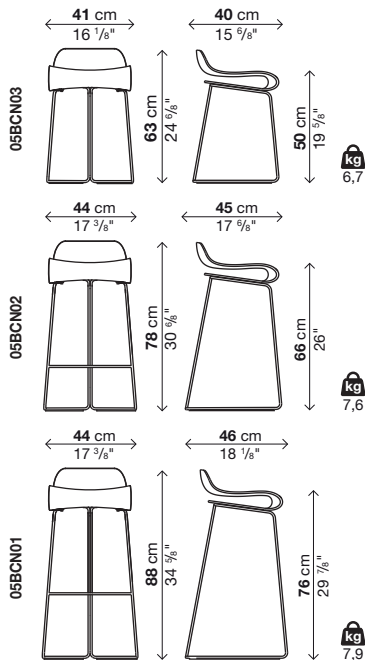

# BCN

## Tabouret piètement bois

### Finition coque:

Hêtre massif

Hêtre massif laqué assorti au coloris de l'assise

### Finition coque:

Blanc PBT (reference couleur "Polypropylène blanc PP01")

Noir PBT (reference couleur "Polypropylène noir PP03")

Vert fluo PBT (reference couleur "Polypropylène vert fluo PP06")

Corail rouge PBT (reference couleur "Polypropylène corail rouge PP07")



→ La couleur noire, plus que d'autres couleurs, met en évidence certaines caractéristiques telles que les "ombres".

→ Emballages renforcés voir page 205.

Code	Base	Prix en EURO	Colis	m <sup>3</sup>	Kg
05BCN08	hêtre		1	0,26	10,5
	en teinte à l'assise				

chaque colis 1 tabouret

Les commandes de plus de 6 pièces seront livrées démontées.

	Colis	m <sup>3</sup>	Kg
 n° 3	1	0,13	12,1
 n° 6	1	0,22	23,5
A  n° 3	1	0,42	13

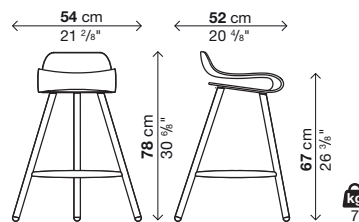

# BCN

## Tabouret à hauteur réglable

### Finition du métal:

Acier chromé

Acier laqué en teinte coordonnée à l'assise

### Finition coque:

Blanc PBT (reference couleur "Polypropylène blanc PP01")

Noir PBT (reference couleur "Polypropylène noir PP03")

Vert fluo PBT (reference couleur "Polypropylène vert fluo PP06")

Corail rouge PBT (reference couleur "Polypropylène corail rouge PP07")

→ La couleur noire, plus que d'autres couleurs, met en évidence certaines caractéristiques telles que les "ombres".

→ Emballages renforcés voir page 205.

Code	Finition du métal	Prix en EURO	Colis	m <sup>3</sup>	Kg
05BCN04	en teinte à l'assise acier chromé		1	0,2	13

chaque colis 1 tabouret

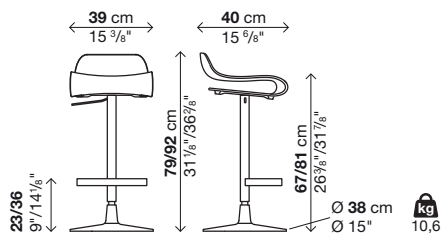

# BCN

## Hocker auf Kufengestell

### Metallausführung:

Verchromter Stahl

Lackierter Stahl im Farbton der Sitzfläche

### Sitzausführung:

PBT in Weiß (Farbähnlich wie "Polypropylen weiss PP01")

PBT in Schwarz (Farbähnlich wie "Polypropylen schwarz PP03")

PBT in Fluogrün (Farbähnlich wie "Polypropylen fluogrün PP06")

PBT in Rot Koralle (Farbähnlich wie "Polypropylen rot Koralle PP07")





→ Die Farbe Schwarz zeigt im Vergleich zu den anderen Farben eine verstärkte Neigung zu "Schattierungen", die auf das Material zurückzuführen sind und völlig der Norm entsprechen.

→ Verstärkte Verpackungsmaterialien siehe Seite 205.

Art.-Nr.	Höhe (cm.)	Beine	Preis in EURO	Kolli	V. m <sup>3</sup>	Kg
05BCN03	50	im Farbton der Sitzfläche Verchromter Stahl		1	0,13	8
05BCN02	66	im Farbton der Sitzfläche Verchromter Stahl		1	0,19	10
05BCN01	76	im Farbton der Sitzfläche Verchromter Stahl		1	0,21	10,2

Ein Hocker pro Frachtstück

Bei Bestellungen mit mehr als 6 Produkte, werden Diese demontiert geliefert - Sitz und Untergestell getrennt.

	Kolli	m <sup>3</sup>	Kg
 Nr. 3	1	0,13	12,1
 Nr. 6	1	0,22	23,5
H.50  Nr. 3	1	0,13	11
H.66/76  Nr. 3	1	0,22	15

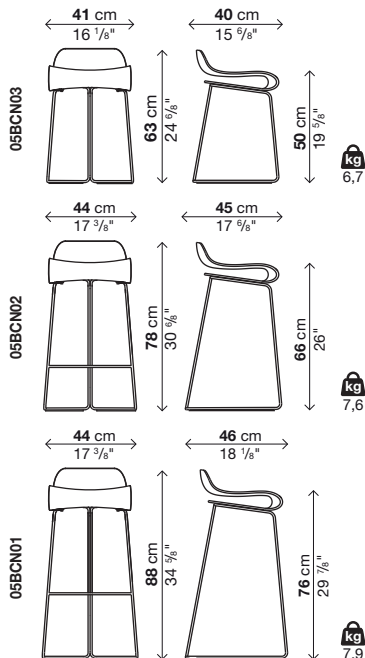

# BCN

## Hocker mit Untergestell aus Holz

### Ausführung Untergestell:

Massives Buchenholz

Massives Buchenholz, lackiert in Farbe der Sitzfläche

### Sitzausführung:

PBT in Weiß (Farbähnlich wie "Polypropylen weiss PP01")

PBT in Schwarz (Farbähnlich wie "Polypropylen schwarz PP03")

PBT in Fluogrün (Farbähnlich wie "Polypropylen fluogrün PP06")

PBT in Rot Koralle (Farbähnlich wie "Polypropylen rot Koralle PP07")



→ Die Farbe Schwarz zeigt im Vergleich zu den anderen Farben eine verstärkte Neigung zu "Schattierungen", die auf das Material zurückzuführen sind und völlig der Norm entsprechen.

→ Verstärkte Verpackungsmaterialien siehe Seite 205.

Art.-Nr.	Untergestell	Preis in EURO	Kolli	V. m <sup>3</sup>	Kg
05BCN08	Buchenholz im Farbton der Sitzfläche		1	0,26	10,5

Ein Hocker pro Frachtstück

Bei Bestellungen mit mehr als 6 Produkte, werden Diese demontiert geliefert - Sitz und Untergestell getrennt.

	Kolli	m <sup>3</sup>	Kg
 Nr. 3	1	0,13	12,1
 Nr. 6	1	0,22	23,5
 Nr. 3	1	0,42	13

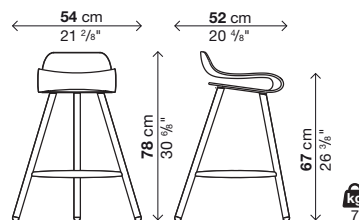



# BCN

## Höhenverstellbarer Hocker

### Metallausführung:

Verchromter Stahl

Lackierter Stahl im Farbton der Sitzfläche

### Sitzausführung:

PBT in Weiß (Farbähnlich wie "Polypropylen weiss PP01")

PBT in Schwarz (Farbähnlich wie "Polypropylen schwarz PP03")

PBT in Fluogrün (Farbähnlich wie "Polypropylen fluogrün PP06")

PBT in Rot Koralle (Farbähnlich wie "Polypropylen rot Koralle PP07")

→ Die Farbe Schwarz zeigt im Vergleich zu den anderen Farben eine verstärkte Neigung zu "Schattierungen", die auf das Material zurückzuführen sind und völlig der Norm entsprechen.

→ Verstärkte Verpackungsmaterialien siehe Seite 205.

Art.-Nr.	Metallausführung	Preis in EURO	Kauf	V. m <sup>3</sup>	Kg
05BCN04	im Farbton der Sitzfläche Verchromt Stahl		1	0,2	13

Ein Hocker pro Frachtstück

